



Operating System Practice

Che-Wei Chang

chewei@mail.cgu.edu.tw

Department of Computer Science and Information
Engineering, Chang Gung University

Course Roadmap

Advanced Operating System Concepts

- Concepts and Implementation of File System
- Storage Management and I/O Devices
- System Protection and Security

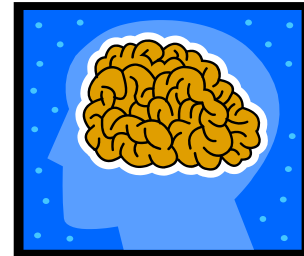

Exercises on PC and Emulators

- Concepts of the Linux Kernel
- Real-Time System Knowledge
- Android Programming on Android Emulator

Embedded System Exercises

- Introduction to Embedded System
- Tools and Techniques to Build Embedded Systems
- Implementation on Embedded System Evaluation Boards





Introduction to Linux

Advantages of Linux

- ▶ Linux is free, both in source code and cost, due to the GPL
- ▶ Linux is fully customizable in all its components
- ▶ Linux can runs on low-end, inexpensive hardware platforms, e.g., one with 4 MB RAM
- ▶ Linux systems are stable
- ▶ The Linux kernel can be very small and compact
- ▶ Linux is highly compatible with many common applications and functions
- ▶ Linux is well-supported



Different Type of Operating System Kernels

▶ Monolithic kernel

- The entire operating system is working in kernel space
- All parts of the kernel share the same kernel-level memory
- Kernel components might affect other components
- The Linux kernel is an example

▶ Microkernel

- Kernel functions are partitioned into components
- Communications are via inter process communication (IPC) protocol
- The L4 microkernel is an example



Monolithic Kernel and Microkernel

Monolithic Kernel

Microkernel

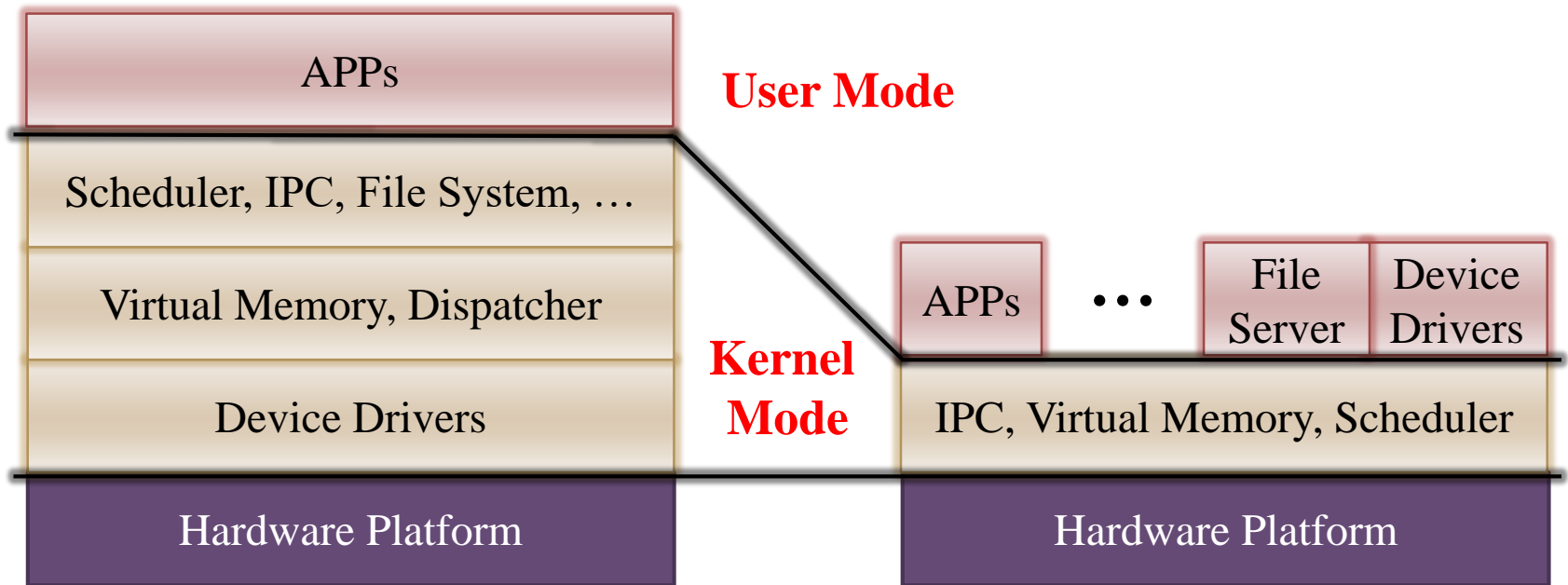

Approaches for Virtualization

- ▶ Virtual Machines on an Host OS
 - For example: VMWare Workstation, Oracle VM VirtualBox
 - Easy to use and install
- ▶ Hypervisors on a Hardware Platform
 - For example: Xen
 - High perform with a very slim software layer
- ▶ Microkernel
 - For example: OKL4 Microkernel
 - Many functions to support the routines of an OS



History of Linux (1 / 2)

- ▶ 1965: Multiplexed Information and Computing Service (Multics)
 - It is a mainframe timesharing operating system
 - It is developed by Bell Lab, MIT and GE
 - It shows the vision and concept of operating systems
- ▶ 1973: Uniplexed Information and Computing System (UNIX)
 - It has been re-written in C to be portable and quite popular
 - It became closed source in 1979



History of Linux (2/2)

- ▶ 1984: Minix
 - It is on X86 architecture
 - It is originally for education
- ▶ 1991: Linux 0.02
 - It runs on X86
 - It is open source
 - It can be compiled by gcc
 - Everyone can contribute new code to it

Hello everybody out there using minix- I'm doing a (free) operation system (just a hobby, won't be big and professional like gnu) for 386(486) AT clones.



Features of Linux

- ▶ Monolithic kernel
 - It is large and complex
 - Most commercial Unix variants are monolithic
- ▶ Dynamically linked module
 - It is able to automatically load and unload modules on demand
- ▶ Kernel threading
 - A kernel thread is an execution context that can be independently scheduled
 - Context switches between kernel threads are usually much less expensive than context switches between ordinary processes
- ▶ Multithreaded application support
- ▶ Preemptive kernel
- ▶ Multiprocessor support
- ▶ Filesystem support



Design Principles

- ▶ Linux is a multiuser, multitasking system with a full set of UNIX-compatible tools
- ▶ Its file system adheres to traditional UNIX semantics, and it fully implements the standard UNIX networking model
- ▶ Main design goals are speed, efficiency, and standardization
- ▶ Linux is designed to be compliant with the relevant POSIX documents



Kernel Modules

- ▶ Sections of kernel code that can be compiled, loaded, and unloaded independent of the rest of the kernel
- ▶ A kernel module may typically implement a device driver, a file system, or a networking protocol
- ▶ The module interface allows third parties to write and distribute, on their own terms, device drivers or file systems that could not be distributed under the GPL
- ▶ Kernel modules allow a Linux system to be set up with a standard, minimal kernel, without any extra device drivers built in
- ▶ Three components to Linux module support
 - module management
 - driver registration
 - conflict resolution



Module Management

- ▶ Supports loading modules into memory and letting them talk to the rest of the kernel
- ▶ Module loading is split into two separate sections:
 - Managing sections of module code in kernel memory
 - Handling symbols that modules are allowed to reference
- ▶ The module requestor manages currently unloaded modules
 - It also regularly queries the kernel to see whether a dynamically loaded module is still in use
 - Unload a module when it is no longer actively needed



Driver Registration

- ▶ Allows modules to tell the rest of the kernel that a new driver has become available
- ▶ The kernel maintains dynamic tables of all known drivers, and provides a set of routines to allow drivers to be added to or removed from these tables at any time
- ▶ Registration tables include the following items:
 - Device drivers
 - File systems
 - Network protocols
 - Binary format



Major and Minor Numbers

- ▶ Major number
 - Each device driver is identified by a unique major number
 - This number is assigned by the Linux Device Registrar
- ▶ Minor number
 - This uniquely identifies a particular instance of a device
 - If there are three devices with the same device driver, they will have the same major number but different minor numbers
- ▶ `mknod [device name][bcp] [Major] [Minor]`
 - b: block devices
 - c: character devices
 - p: a FIFO file



Process Management

- ▶ Linux process management separates the creation of processes and the running of a new program into two distinct operations
 - The `fork()` system call creates a new process
 - A new program is run after a call to `exec()`
- ▶ A process encompasses all the information that the operating system must maintain to track the context of a single execution of a single program
- ▶ Process properties fall into three groups:
 - Identity
 - Environment
 - Context



Process Identity

- ▶ Process ID (PID)
 - The unique identifier for the process
 - It is used to specify processes to the operating system when an application makes a system call to signal, modify, or wait for another process
- ▶ Credentials
 - Each process must have an associated user ID and one or more group IDs that determine the process's rights to access system resources and files
- ▶ Namespace
 - Each process is associated with a specific view of the filesystem hierarchy



Process Environment

- ▶ The process's environment is inherited from its parent
 - The argument vector lists the command-line arguments used to invoke the running program; conventionally starts with the name of the program itself
 - The environment vector is a list of “NAME=VALUE” pairs that associates named environment variables with arbitrary textual values
- ▶ Passing environment variables among processes and inheriting variables by a process's children are flexible
- ▶ The environment-variable mechanism provides a customization of the operating system for each process

Process Context

- ▶ The (constantly changing) state of a running program at any point in time
- ▶ The scheduling context is the most important part of the process context; it is the information that the scheduler needs to suspend and restart the process
- ▶ The signal-handler table defines the routine in the process's address space to be called when specific signals arrive
- ▶ The virtual-memory context of a process describes the full contents of the its private address space



Kernel Synchronization

- ▶ Kernel synchronization requires a framework that will allow the kernel's critical sections to run without interruption by another critical section
 - Big kernel lock
 - The kernel guarantees that it can proceed without the risk of concurrent access of shared data structures
- ▶ Interrupt service routines are separated into a *top half* and a *bottom half*
 - The top half is a normal interrupt service routine, and runs with recursive interrupts disabled
 - The bottom half runs with all interrupts enabled



Interrupt Protection Levels

- ▶ Each level may be interrupted by code running at a higher level, but will never be interrupted by code running at the same or a lower level.

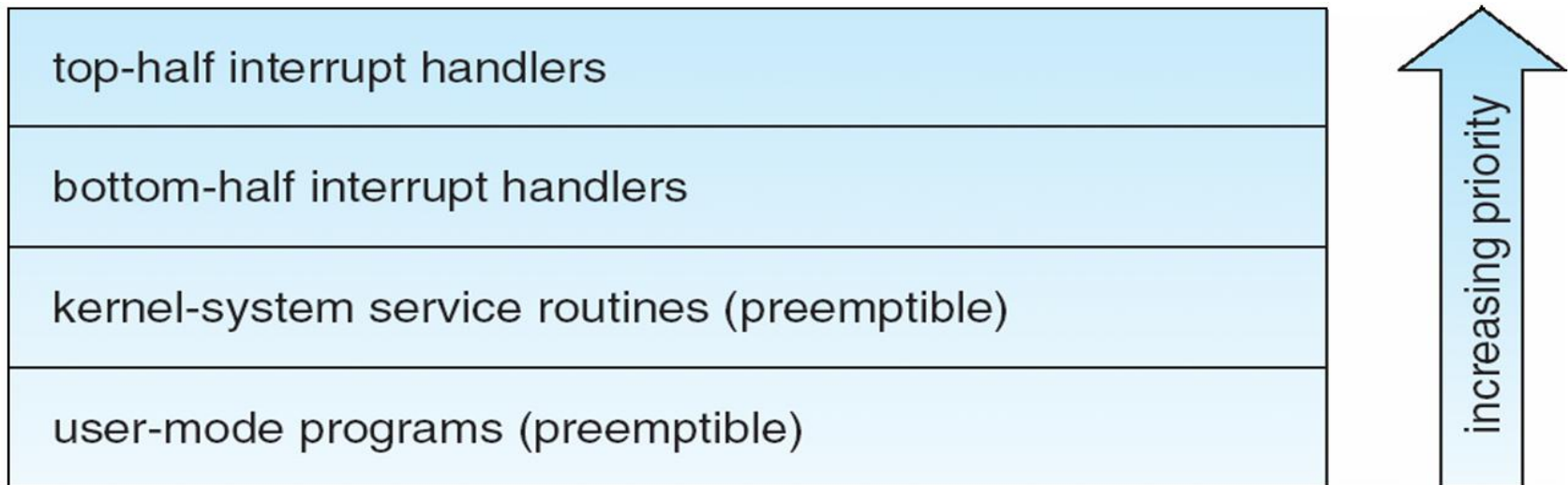

Process Scheduling

- ▶ Linux uses two process-scheduling algorithms
 - A time-sharing algorithm
 - A real-time algorithm for tasks where absolute priorities are more important than fairness
- ▶ For time-sharing processes, Linux uses a prioritized, credit based algorithm
- ▶ Linux implements the FIFO and round-robin real-time scheduling classes



Executing and Loading User Programs

- ▶ Linux maintains a table of functions for loading programs
 - it gives each function the opportunity to try loading the given file when an exec system call is made
- ▶ The registration of multiple loader routines allows Linux to support both the ELF and a.out binary formats
- ▶ Initially, binary-file pages are mapped into virtual memory
 - Only when a program tries to access a given page will a page fault result in that page being loaded into physical memory
- ▶ An ELF-format binary file consists of a header followed by several page-aligned sections
 - The ELF loader works by reading the header and mapping the sections of the file into separate regions of virtual memory



Proc File System

- ▶ The proc file system does not store data, rather, its contents are computed on demand according to user file I/O requests
- ▶ When data is read from one of these files, proc collects the appropriate information, formats it into text form and places it into the requesting process's read buffer
- ▶ `cat /proc/cpuinfo` will get the CPU information
 - vendor ID
 - CPU family, CPU cores
 - cache size, TLB size
 - ...





Real-Time Systems

An Example of Real-Time Designs

- ▶ A camera periodically takes a photo
- ▶ The image recognition result will be produced before the next period
- ▶ If there is an obstacle, the train automatically brakes

Time of a Period = $150/50 = 3s$

Distance of a Period = $(400 - 100)/2 = 150m$

Braking: $-12.5m/s^2$

Max Seed: $50m/s$

Distance to Stop
 $25 \times (50/12.5) = 100m$

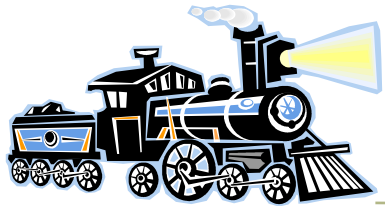

Camera Range: 400m

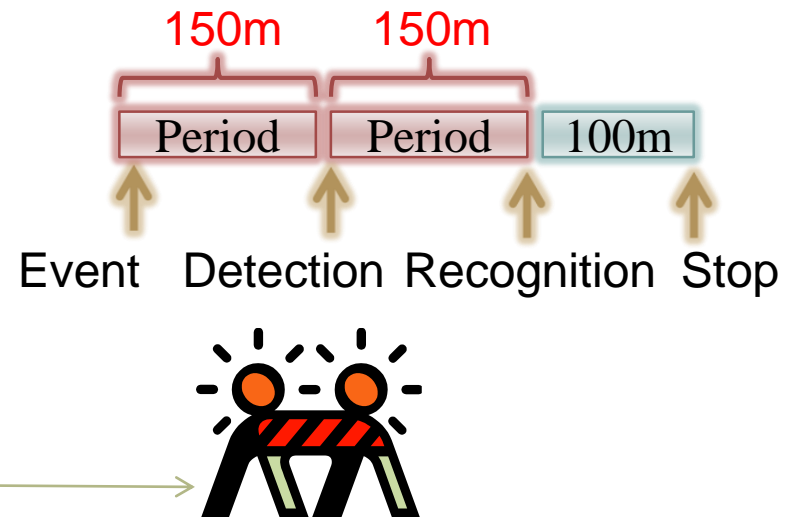

Multiple Real-Time Tasks

▶ Playing piano: 2 days per 4 days 

Playing chess : 1.5 days per 3 days 

▶ Case 1: Playing piano is always more important

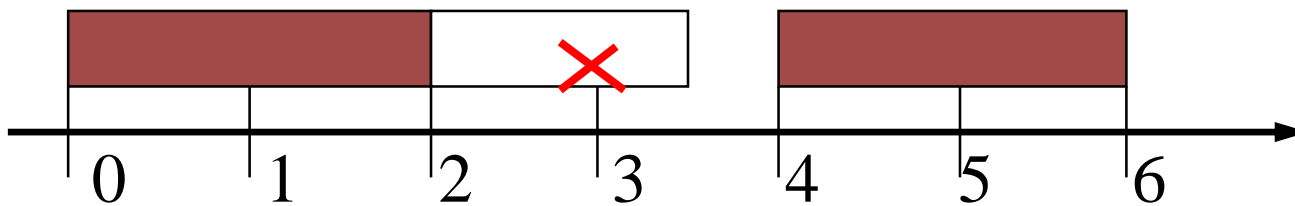

▶ Case 2: Doing whatever is more urgent

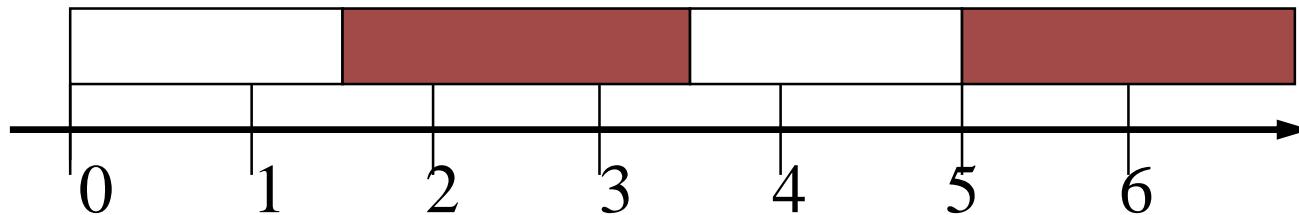

Tentative Assumptions

- ▶ Processes are independent
- ▶ Processes are all periodic
- ▶ The deadline of a request is its next request time
- ▶ A scheduler consists of a priority assignment policy and a priority-driven scheduling mechanism

Reference: C.L. Liu and James. W. Layland, “Scheduling Algorithms for Multiprogramming in a Hard Real-Time Environment,” JACM, Vol. 20, No.1, January 1973, pp. 46-61



Definitions

- ▶ The **response time** of a request for a process is the time span between the request and the end of the response to that request
- ▶ A **critical instant** of a process is an instant at which a request of that process has the longest response time
- ▶ A **critical interval** for a process is the time interval between the start of a critical instant and the deadline of the corresponding request of the process
 - A critical instant for any process occurs whenever the process is requested simultaneously with requests for all higher priority processes

An observation: If a process can complete its execution within its critical interval, it is schedulable at all time!



A Static Scheduling Algorithm— Rate Monotonic Scheduling

- ▶ A static priority is assigned to each task based on the inverse of its period
 - A task with shorter period → higher priority
 - A task with longer period → lower priority
 - For example:
 - P_1 has its **period 50** and execution time 20
 - P_2 has its **period 100** and execution time 37
 - P_1 is assigned a higher priority than P_2

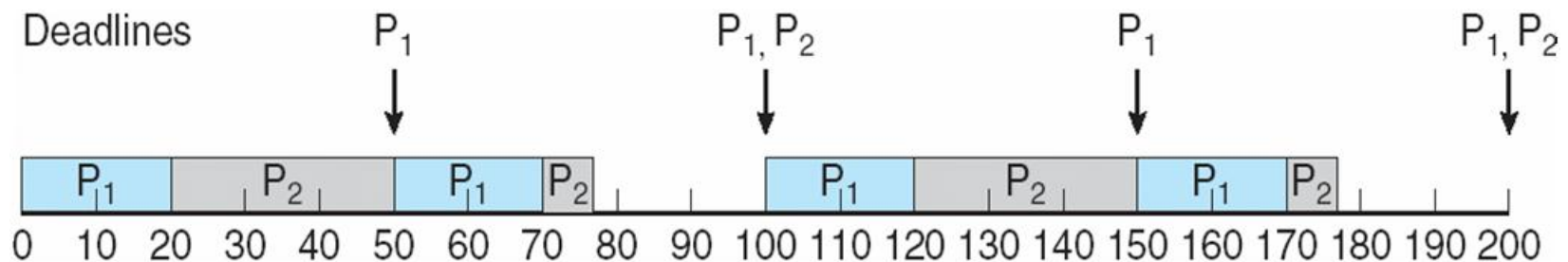

Property of Rate Monotonic Scheduling

- ▶ The **rate monotonic** (RM) priority assignment assigns processes priorities according to their request rates
 - If a feasible fixed priority assignment exists for some process set, then the rate monotonic priority assignment is feasible for that process set

➔ The optimal fixed priority assignment

Proof. Exchange the priorities of two tasks if their priorities are out of RMS order.

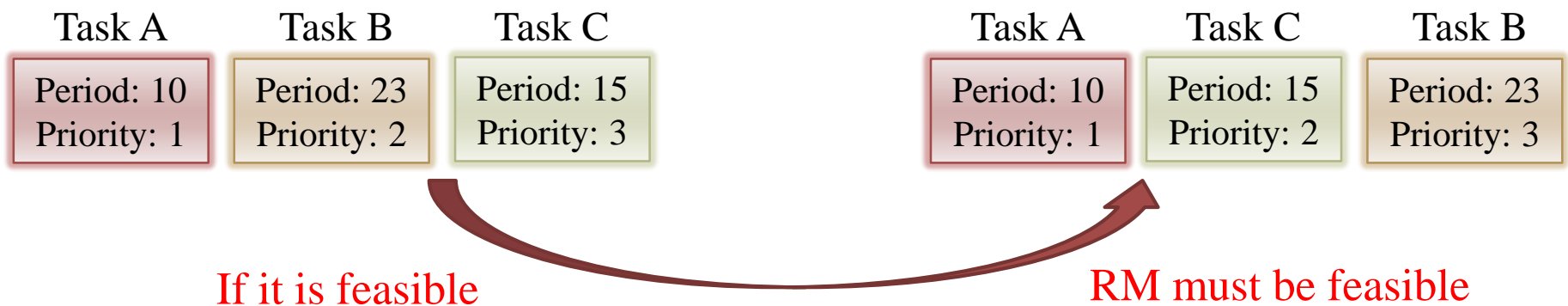

A Dynamic Scheduling Algorithm— Earliest Deadline First Scheduling

- ▶ Dynamic priorities are assigned according to deadlines
 - The earlier the deadline, the higher the priority
 - The later the deadline, the lower the priority
 - For example:
 - P_1 has its period 50 and execution time 25
 - P_2 has its period 80 and execution time 35

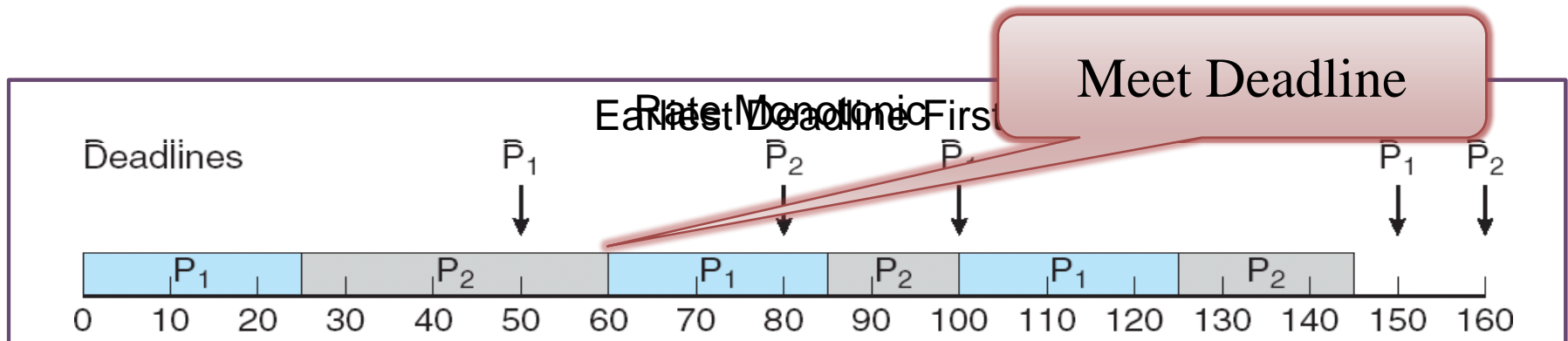

Real-Time Analysis

- ▶ For a task τ_i with the period P_i and the execution time C_i , the utilization U_i of τ_i is defined as $U_i = \frac{C_i}{P_i}$
- ▶ For a real-time task set \mathbf{T} the total utilization of the task set is $\sum_{\tau_i \in \mathbf{T}} U_i$
- ▶ If $\sum_{\tau_i \in \mathbf{T}} U_i \leq 69\%$, Rate Monotonic Scheduling can schedule all tasks in \mathbf{T} to meet all deadlines
 - More precisely, for n tasks, the i -th task can meet deadline if

$$\sum_{j=1}^i \frac{c_j}{p_j} \leq i(2^{1/i} - 1)$$

- ▶ If and only if $\sum_{\tau_i \in \mathbf{T}} U_i \leq 100\%$, Earliest Deadline First Scheduling can schedule all tasks in \mathbf{T} to meet all deadlines

Reference: C.L. Liu and James. W. Layland, "Scheduling Algorithms for Multiprogramming in a Hard Real-Time Environment," JACM, Vol. 20, No.1, January 1973, pp. 46-61



Scheduling Overheads

► Context Switching

- Needed either when a process is preempted by another process, or when a process completes its execution
- Stack Discipline

If process A preempts process B, process A must complete before process B can resume

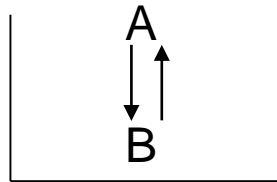

If it is obeyed, charge the cost of preemption (context switching cost) once to the preempting process!



Least Slack Time Algorithm

- ▶ The least slack time algorithm (LST), which assigns processes priorities inversely proportional to their slack times is also optimal if context switching cost can be ignored
 - The slack time of a process is $d(t) - t - c(t)$
 - t : current time
 - $d(t)$: deadline
 - $c(t)$: remaining execution time
 - An example
 - The time $t = 0$, two task have the same deadline 20
 - Task 1 has $c(t) = 7$, and task 2 has $c(t) = 8$

$t_1 \rightarrow 13$ $t_1 \rightarrow 11$ $t_1 \rightarrow 11$ $t_1 \rightarrow 9$
 $t_2 \rightarrow 12$ $t_2 \rightarrow 12$ $t_2 \rightarrow 10$ $t_2 \rightarrow 10$



So many context switches!

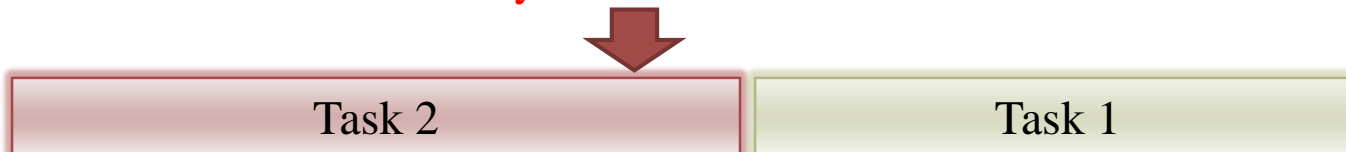



Process Synchronization

Basic Concept

- ▶ Processes might share non-preemptible resources or have precedence constraints
- ▶ Papers for discussion:
 - L. Sha, R. Rajkumar, J.P. Lehoczky, “Priority Inheritance Protocols: An Approach to Real-Time Synchronization,” IEEE Transactions on Computers, 1990.
 - A.K. Mok, “The Design of Real-Time Programming Systems Based on Process Models,” IEEE Real-Time Systems Symposium, Dec 1994.



Process Synchronization

► Motivation

- Can we find an efficient way to analyze the schedulability of a process set (systematically)
- What kinds of restrictions on the use of communication primitives are needed so as to efficiently solve the restricted scheduling problem
- How can we control the priority inversion problem
- The lengths of critical sections might be quite different



Blocking and Preemption

- ▶ Blocking: a higher-priority process is forced to wait for the execution of a lower-priority process
- ▶ Preemption: a low-priority process is forced to wait for the execution of a high-priority process

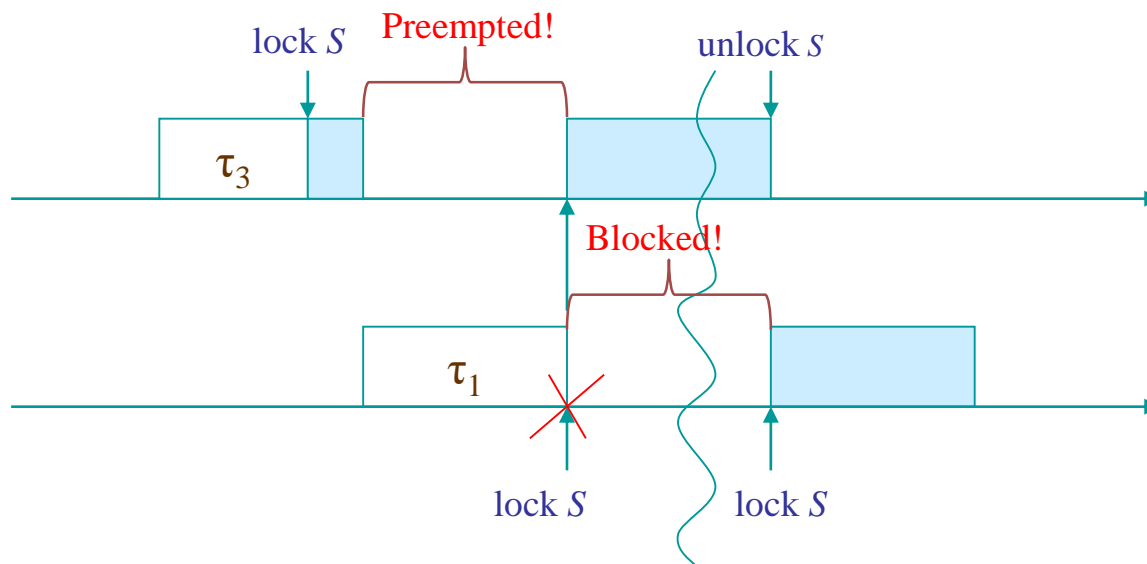

Priority Inversion

- ▶ When there are a lot of tasks having priority between that of τ_1 and τ_3 , there are a lot of priority inversions

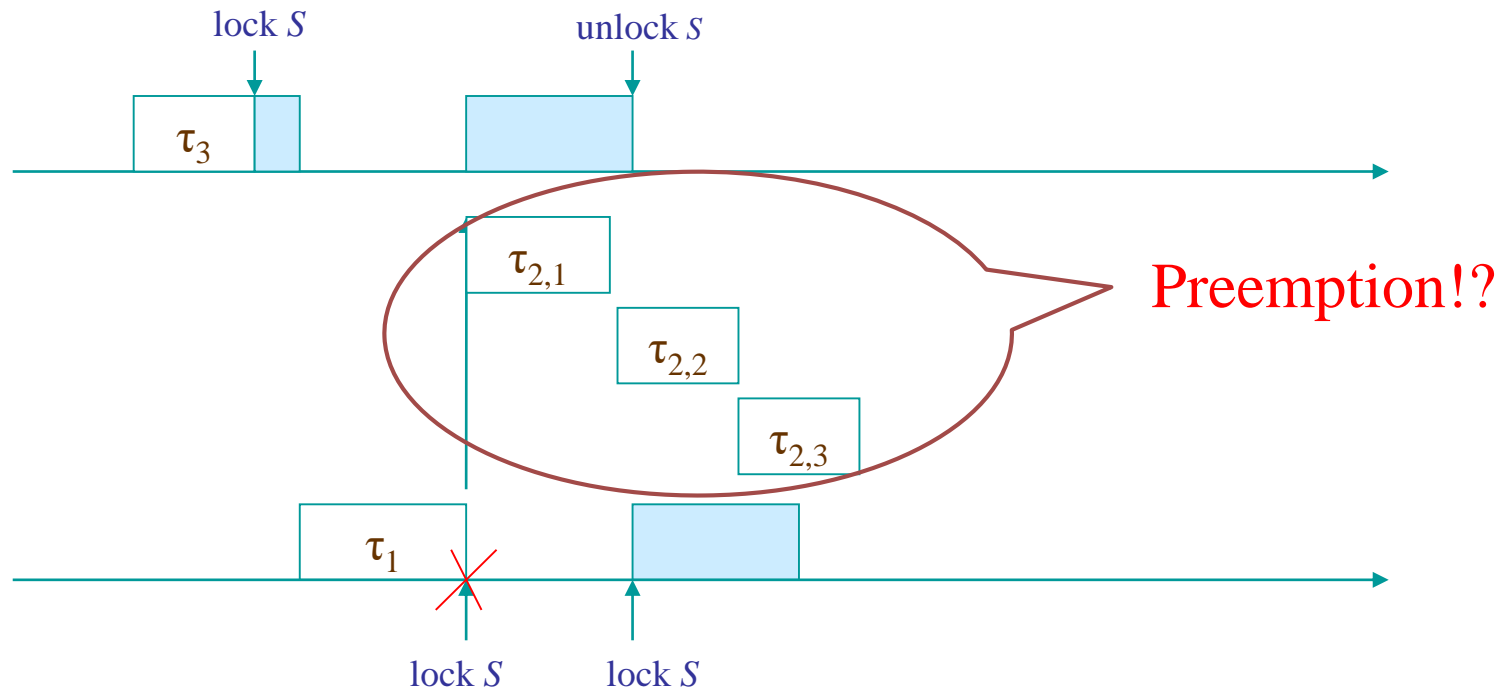

Priority Inheritance Protocol (PIP)

▶ Priority-Driven Scheduling

- The process which has the highest priority among the ready processes is assigned the processor

▶ Synchronization

- Process τ_i must obtain the lock on the semaphore guarding a critical section before τ_i enters the critical section
- If τ_i obtains the required lock, τ_i enters the corresponding critical section; otherwise, τ_i is blocked and said to be blocked by the process holds the lock on the corresponding semaphore
- Once τ_i exits a critical section, τ_i unlocks the corresponding semaphore and makes its blocked processes ready

▶ Priority Inheritance

- If a process τ_i blocks higher priority processes, τ_i inherits the highest priority of the process blocked by τ_i
- Priority inheritance is transitive



Properties of PIP

- ▶ No priority inversion

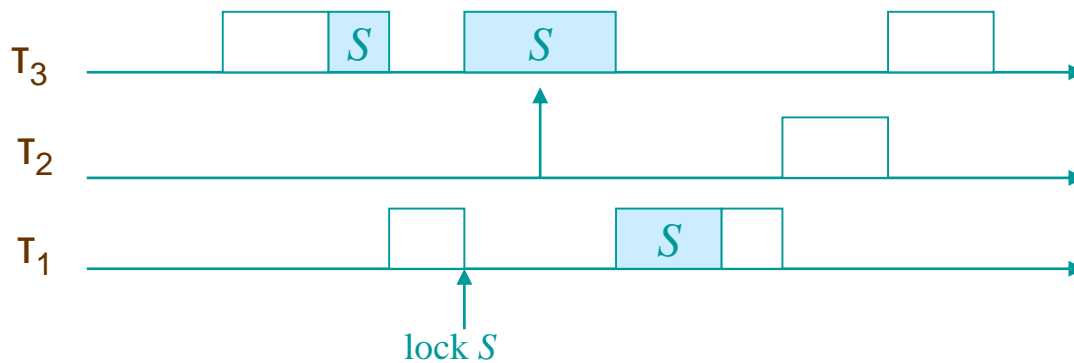

- ▶ A semaphore S can be used to cause inheritance blocking to task J only if S is accessed by a task which has a priority lower than that of J and might be accessed by a task which has a priority equal to or higher than that of J .



Concerns of PIP

- ▶ A chain of blocking is possible

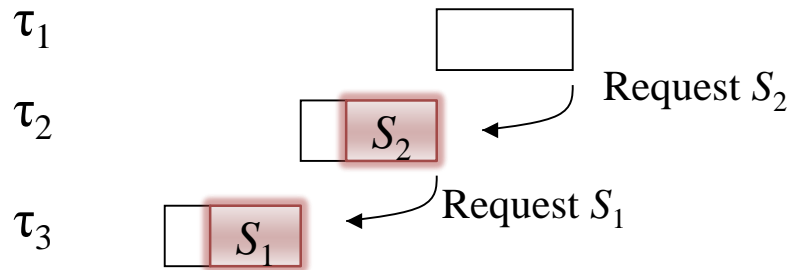

- ▶ A deadlock can be formed

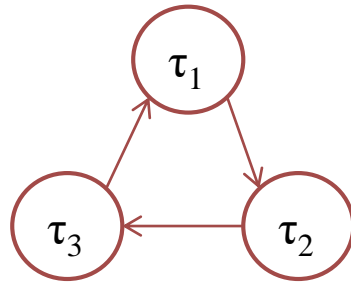

Priority Ceiling Protocol (PCP)

- ▶ The priority ceiling of a semaphore is the priority of the highest priority task that may lock the semaphore
- ▶ The Basic Priority Inheritance Protocol + Priority Ceiling
- ▶ A task J may successfully lock a semaphore S if S is available, and the priority of J is higher than the highest priority ceiling of all semaphores currently locked by tasks other than J
- ▶ Priority inheritance is transitive



Properties of PCP

- ▶ The priority ceiling protocol prevents transitive blockings
- ▶ The Priority ceiling Protocol prevents deadlock
- ▶ No job can be blocked for more than one critical section of any lower priority job
- ▶ A set of n periodic tasks under the **priority ceiling protocol** can be scheduled by the **rate monotonic algorithm** if the following conditions are satisfied:

$$\forall i, \quad 1 \leq i \leq n, \quad \sum_{j=1}^{i-1} \frac{c_j}{p_j} + \frac{c_i + B_i}{p_i} \leq i(2^{1/i} - 1)$$

where B_i is the worst-case blocking time for τ_i



Example of PCP

- ▶ Consider 4 tasks, t_1 , t_2 , t_3 , and t_4 which have priorities x_1 , x_2 , x_3 , and x_4 , respectively, and assume $x_1 > x_2 > x_3 > x_4$ (x_1 is the highest priority). After we profile the programs of the 4 tasks, we have the following information:
 - Task t_1 will lock semaphore S_1 for 3ms.
 - Task t_2 will lock semaphore S_2 for 10ms and lock semaphore S_1 for 13ms.
 - Task t_3 will lock semaphore S_2 for 8ms and lock semaphore S_3 for 15ms.
 - Task t_4 will lock semaphore S_1 for 15ms and lock semaphore S_3 for 23ms.
 - Please derive the priority ceiling of each semaphore. If priority ceiling protocol is used to manage the semaphore locking, please derive the worst-case blocking time of each task.

Answer: Priority ceilings: $S_1 \rightarrow x_1$, $S_2 \rightarrow x_2$, $S_3 \rightarrow x_3$.

Worst-case blocking times: $t_1 \rightarrow 15\text{ms}$, $t_2 \rightarrow 15\text{ms}$, $t_3 \rightarrow 23\text{ms}$, $t_4 \rightarrow 0\text{ms}$.



Example: Deadlock Avoidance

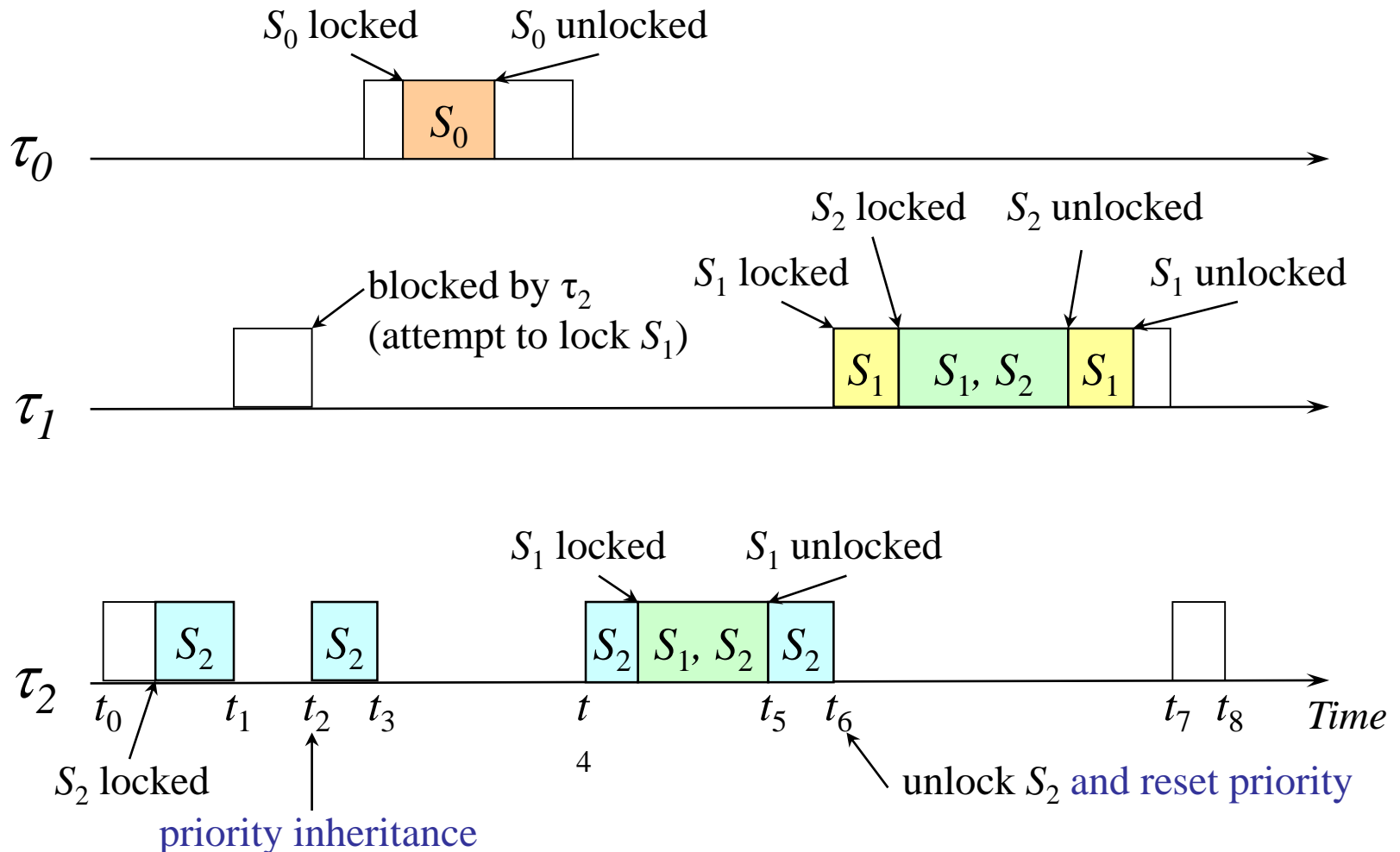

Example: Chain Blocking Avoidance

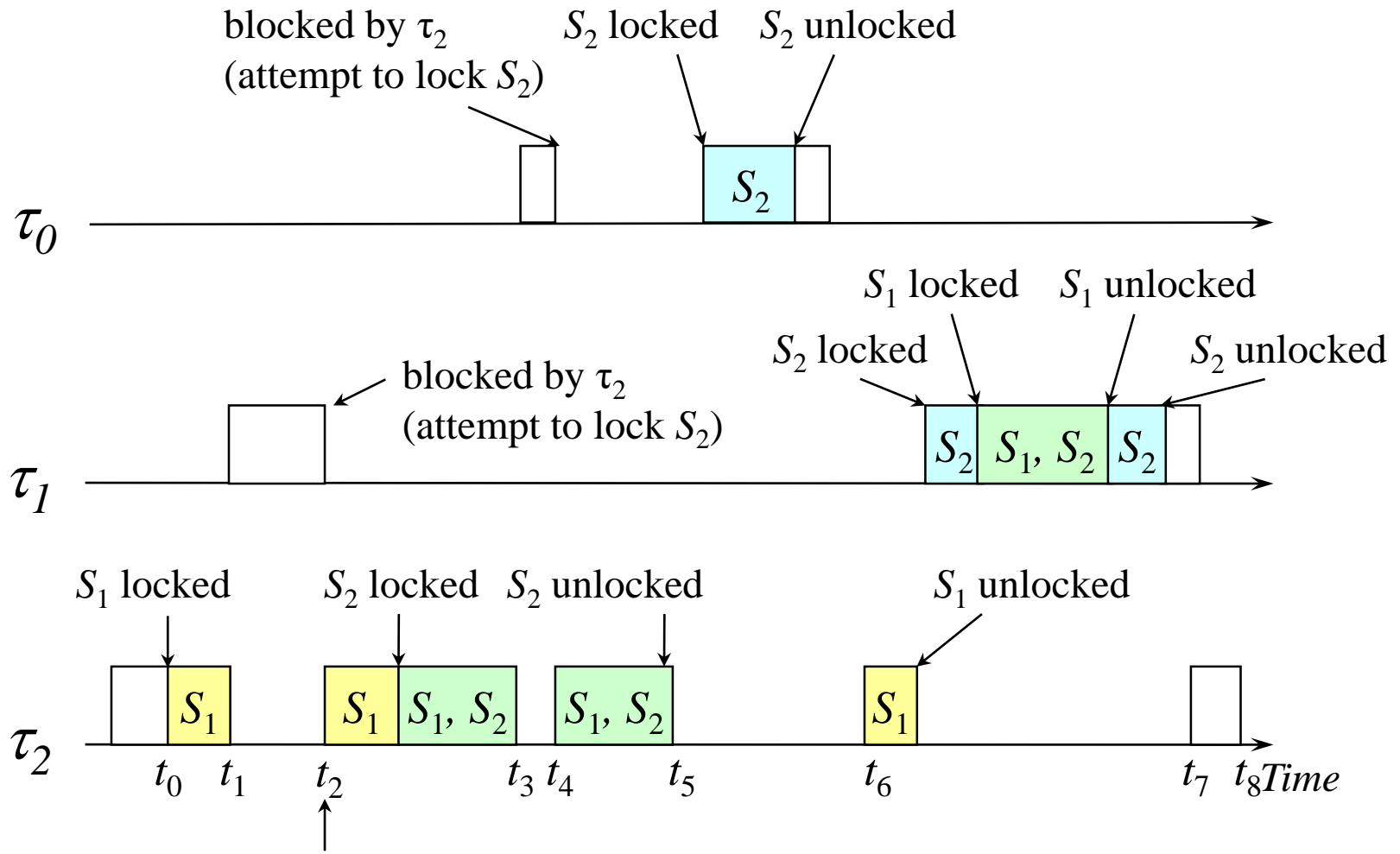

Avoidance blocking occurs!



Rate Monotonic Analysis

Periodic Requirements (1 / 2)

Task τ_1 : $C_1=20$, $P_1=100$, $U_1=0.2$

Task τ_2 : $C_2=40$, $P_2=150$, $U_2=0.267$

Task τ_3 : $C_3=100$, $P_3=350$, $U_3=0.286$

- ▶ Total utilization: $75.3\% \leq 3\left(2^{\frac{1}{3}} - 1\right) = 77.9\%$
- ▶ 24.7% of the CPU is usable for lower-priority background computation



Periodic Requirements (2/2)

Task τ_1 : $C_1=40$, $P_1=100$, $U_1=0.4$

Task τ_2 : $C_2=40$, $P_2=150$, $U_2=0.267$

Task τ_3 : $C_3=100$, $P_3=350$, $U_3=0.286$

- ▶ The utilization of the first two tasks: $66.7\% \leq 2(2^{\frac{1}{2}} - 1) = 82.8\%$
- ▶ The total utilization: $95.3\% > 3(2^{\frac{1}{3}} - 1) = 77.9\%$

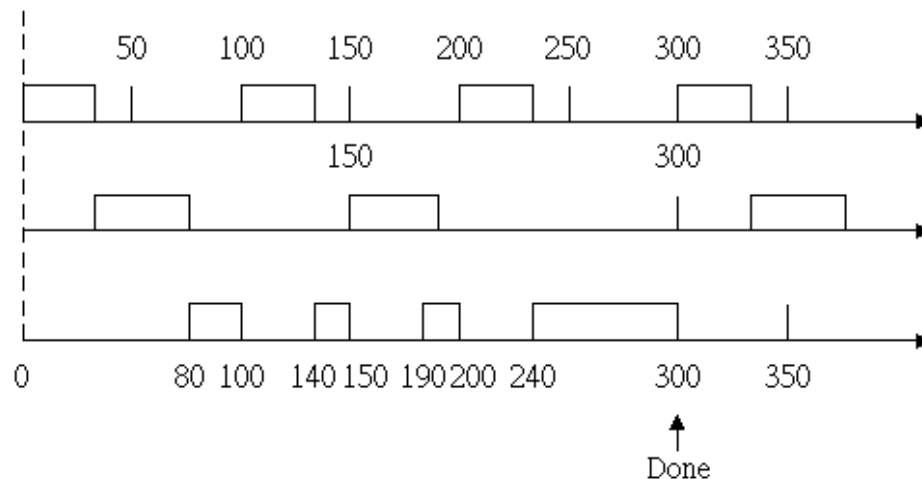

Rate Monotonic Analysis (RMA)

▶ A RMA Example:

- $\tau_1(20,100)$, $\tau_2(30,150)$, $\tau_3(80, 210)$, $\tau_4(100,400)$

- τ_1

- $c_1 \leq 100$

- τ_2

- $c_1 + c_2 \leq 100$ or

- $2c_1 + c_2 \leq 150$

- τ_3

- $c_1 + c_2 + c_3 \leq 100$ or

- $2c_1 + c_2 + c_3 \leq 150$ or

- $2c_1 + 2c_2 + c_3 \leq 200$ or

- $3c_1 + 2c_2 + c_3 \leq 210$

- τ_4

- $c_1 + c_2 + c_3 + c_4 \leq 100$ or

- $2c_1 + c_2 + c_3 + c_4 \leq 150$ or

- ...

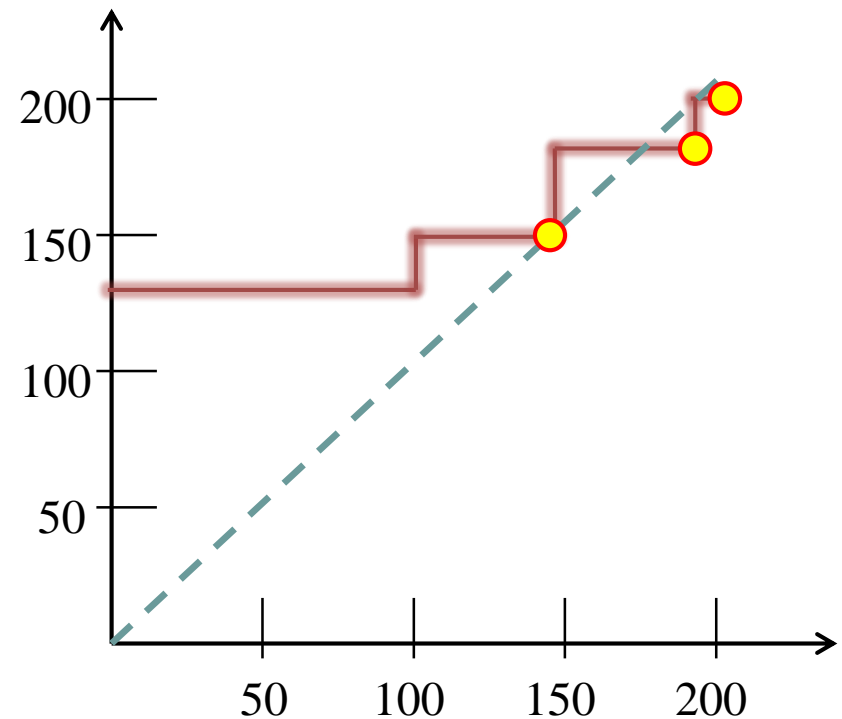

RMA with Blocking Consideration (1 / 2)

- ▶ A RMA Example with blocking time:
 - $\tau_1(20,100)$, $\tau_2(30,150)$, $\tau_3(80, 210)$, $\tau_4(100,400)$
 - τ_1 : (S_1 , 5)
 - τ_2 : (S_2 , 15)
 - τ_3 : (S_1 , 10), (S_3 , 5)
 - τ_4 : (S_2 , 5), (S_3 , 20)
- ▶ What is the priority ceiling of each semaphore?
 - S_1 : τ_1 , S_2 : τ_2 , S_3 : τ_3
- ▶ When PCP is adopted (block once), what is the blocking time of each task?
 - τ_1 : 10, τ_2 : 10, τ_3 : 20, τ_4 : 0



RMA with Blocking Consideration (2/2)

- ▶ A RMA Example with blocking time:
 - For each task, we have to consider the execution time, period, and blocking time
 - $\tau_1(20,100,10)$, $\tau_2(30,150,10)$, $\tau_3(80, 210,20)$, $\tau_4(100,400,0)$
 - τ_1
 - $b_1 + c_1 \leq 100$
 - τ_2
 - $b_2 + c_1 + c_2 \leq 100$ or
 - $b_2 + 2c_1 + c_2 \leq 150$
 - τ_3
 - $b_3 + c_1 + c_2 + c_3 \leq 100$ or
 - $b_3 + 2c_1 + c_2 + c_3 \leq 150$ or
 - $b_3 + 2c_1 + 2c_2 + c_3 \leq 200$ or
 - $b_3 + 3c_1 + 2c_2 + c_3 \leq 210$
 - τ_4
 - ...





Aperiodic Servers

Observation of Aperiodic Tasks

- ▶ Aperiodic tasks run at irregular intervals
- ▶ Aperiodic deadlines
 - Hard deadline: minimum inter-arrival time
 - Soft deadline: best average response time
- ▶ Services such as
 - User requests
 - Device interrupts
 - ...



Scheduling Aperiodic Tasks

- ▶ Polling Server ~ Average Response Time = 50 units

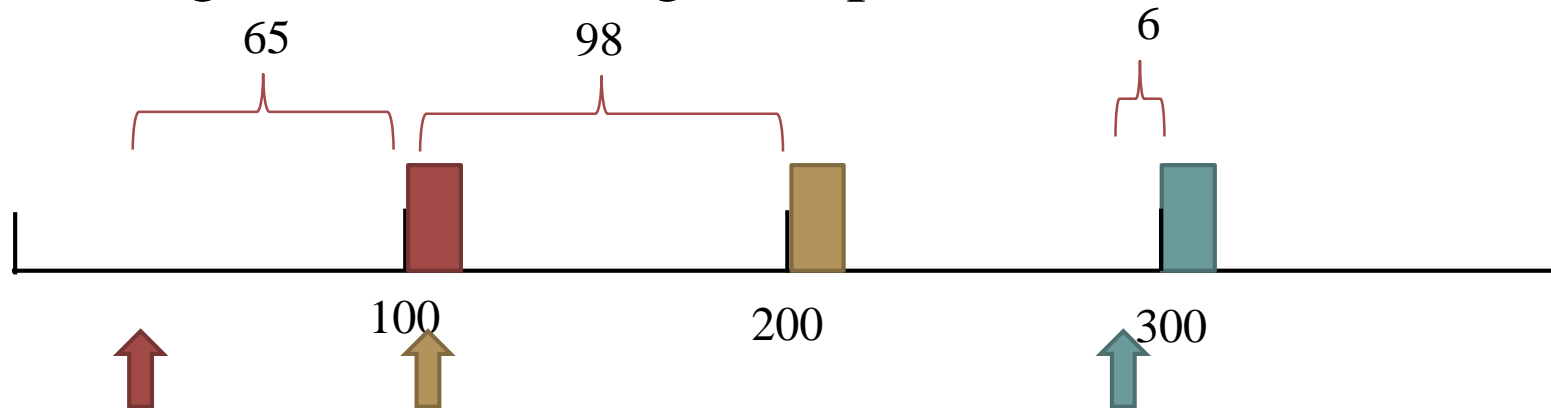

- ▶ Interrupt Server ~ Average Response Time = 1 unit

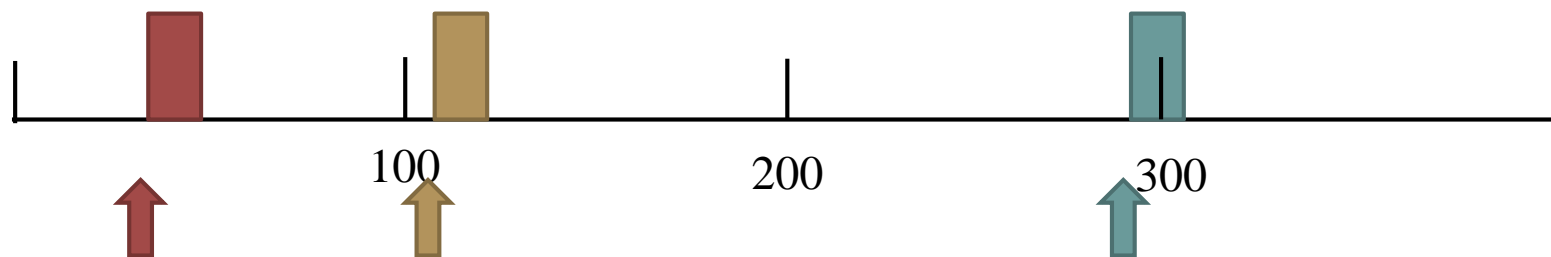

Deferrable Server

- ▶ Polling Server: the average response time is long
- ▶ Interrupt Server: the computing time of aperiodic tasks is difficult to limited
- ▶ Deferrable Server
 - In each period, a deferrable server has a execution budget
 - When execution budget is used up, server execution drops to a lower (background) priority

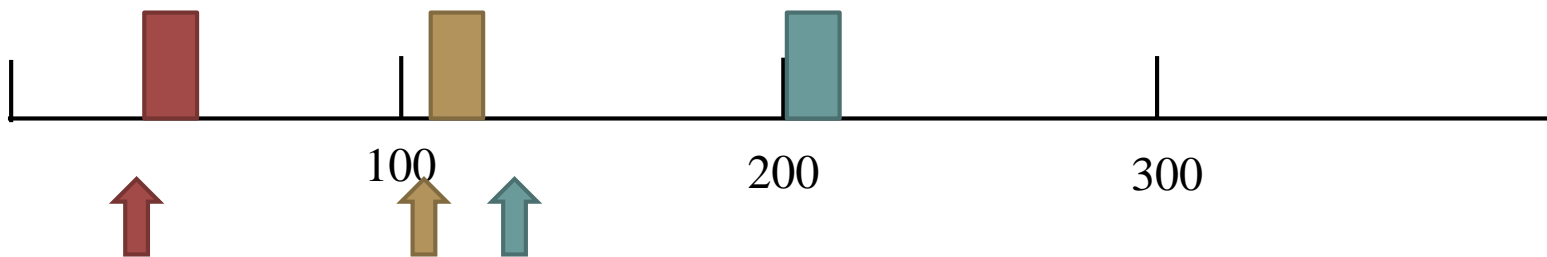

Sporadic Server

- ▶ Deferrable Server might consume two times of the execution budget in short time

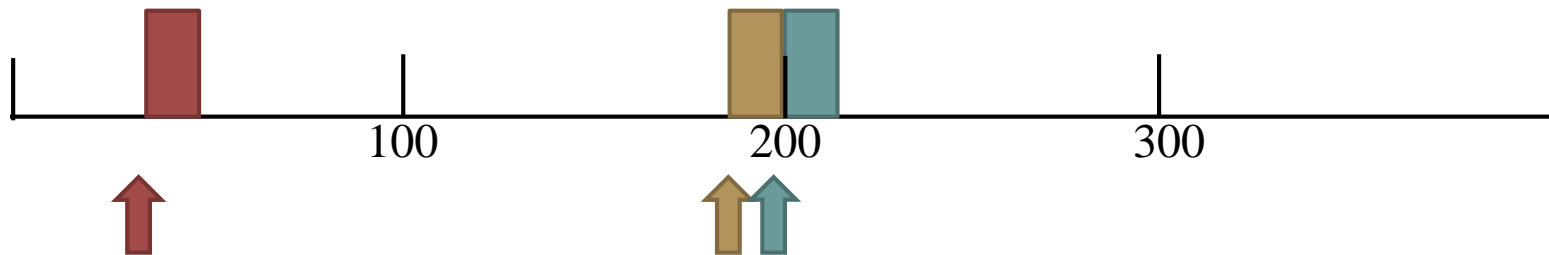

- ▶ Sporadic Server

- Replenishment occurs one “period” after the start of usage

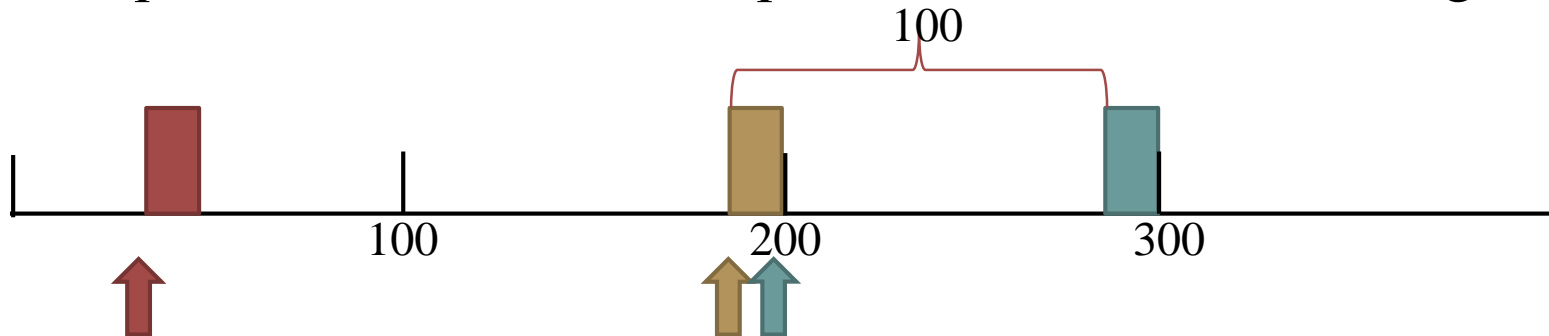

Properties of Sporadic Server

- ▶ A sporadic server differs from a deferrable server in its replenishment policy:
 - A 100 ms deferrable server replenishes its execution budget every 100 ms, no matter when the execution budget is used
 - The affect of a sporadic server on lower priority tasks is no worse than a periodic task with the same period and execution time



An Example of Sporadic Server

- ▶ A sporadic server has a replenishment period 5 and an execution budget 2
- ▶ Each event consumes the execution 1
- ▶ Events arrive at 1, 3, 4, 8, 9

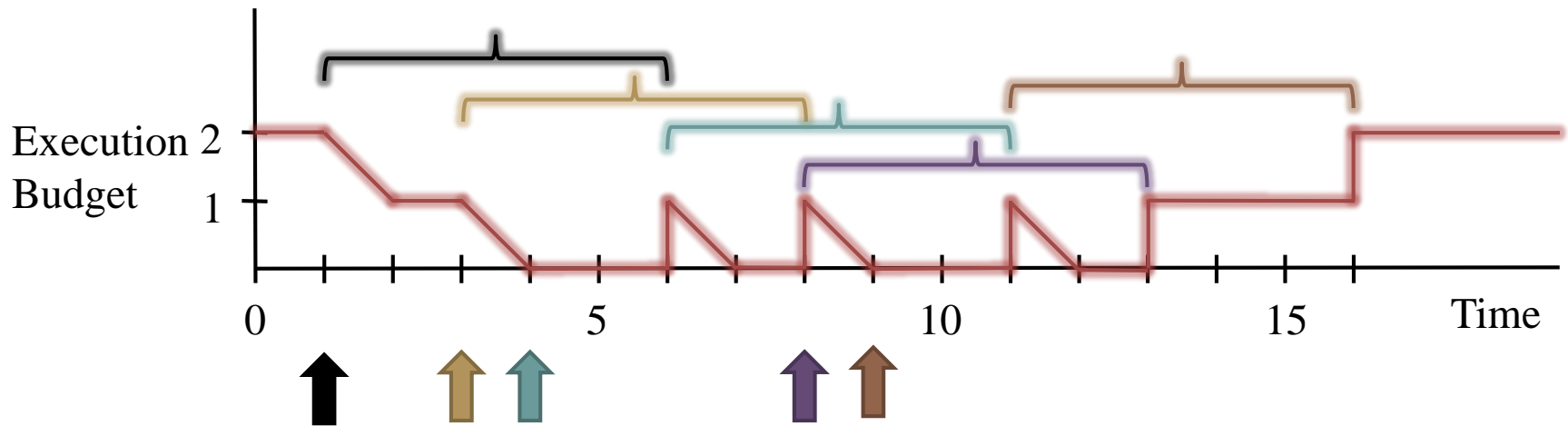

Properties of Sporadic Server

- ▶ For a sporadic server has a replenishment period X and an execution budget Y
 - Given a set of sporadic tasks, If
 - Each of the aperiodic tasks has its minimum inter-arrival time no less than X
 - The total execution of the task set is no more than Y
 - All sporadic tasks can meet the deadline constraints
- ▶ When a system consists of periodic tasks and sporadic servers
 - A sporadic server with replenishment period X and an execution budget Y can be consider as a periodic task with a period X and an execution time Y
 - The system can then use analysis scheme of RM or EDF

